

**AC-6975TB-A
AC-6975TB-D
TOOLBOX**



JOHN DEERE

**INSTALLATION
INSTRUCTIONS**



Introduction

Congratulations on the purchase of your new toolbox! You can be assured your toolbox was constructed and designed with quality and performance in mind. Each component has been rigorously tested to ensure the highest level of acceptance.

This installation manual was compiled for your benefit. Please read and follow the simple installation instructions described in this manual. The contents of this manual are based on the latest product information available at the time of publication. The manufacturer reserves the right to make changes in price, color, materials, equipment, specifications or models at any time without notice.

Inspect for signs of obvious or concealed freight damage. If damage does exist, file a claim with the transportation company immediately. Be sure that all damaged parts are replaced and that the mechanical problems are corrected prior to installation. If you require service, contact your Customer Service.

Mi-T-M® Corporation, 8650 Enterprise Drive, Peosta, IA 52068
1-877-JD-KLEEN / (1-877-535-5336) Fax 563-556-1235
Monday - Friday 8:00 a.m. - 5:00 p.m. CST

Please have the following information available for all service calls:

1. Model Number
2. Date and Place of Purchase

Table of Content

SAFETY	4-5
GENERAL SAFETY RULES.....	4-5
FUNCTIONAL DESCRIPTION	6
MODEL.....	6
NAME OF PARTS	6
INSTALLATION	7-9
MAINTENANCE	10
CLEANING INSTRUCTIONS.....	10
LUBRICATION INSTRUCTIONS.....	10
NOTES	11

Safety

RECOGNIZE SAFETY INFORMATION

This is the safety alert symbol. When you see this symbol in this manual, be alert to the potential for personal injury.

Follow recommended precautions and safe operating practices.



UNDERSTAND SIGNAL WORDS

A "DANGER, WARNING or CAUTION" safety warning will be surrounded by a "SAFETY ALERT BOX." This box is used to designate and emphasize Safety Warnings that must be followed when installing this toolbox.

Accompanying the Safety Warnings are "signal words" which designate the degree or level of hazard seriousness. The "signal words" used in this manual are as follows:

DANGER: Indicates an imminently hazardous situation which, if not avoided, WILL result in death or serious injury.

WARNING: Indicates a potentially hazardous situation which, if not avoided, COULD result in death or serious injury.

CAUTION: Indicates a potentially hazardous situation which, if not avoided MAY result in minor or moderate injury.

⚠ DANGER

⚠ WARNING

⚠ CAUTION

GENERAL SAFETY RULES



WARNING: Read and understand all instructions. Failure to follow all instructions listed below, may result in serious personal injury.

SAVE THESE INSTRUCTIONS





⚠ CAUTION

THIS INSTALLATION REQUIRES THE USE OF POWER TOOLS. SAFETY GLASSES SHOULD BE WORN AT ALL TIMES DURING THE USE OF THE POWER TOOLS.

IF YOU ARE UNABLE TO LIFT A MINIMUM OF 75 LBS., THEN THIS INSTALLATION WILL REQUIRE THE USE OF TWO PEOPLE.

PINCH AREA BETWEEN BODY AND LID OF TOOLBOX.

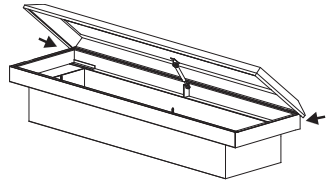

Functional Description

MODEL:

AC-6975TB-A

AC-6975TB-D

NOTE: Some illustrations in this installation manual may show details that differ from those on your own toolbox.

NAME OF PARTS:

Single-Lid Toolbox:

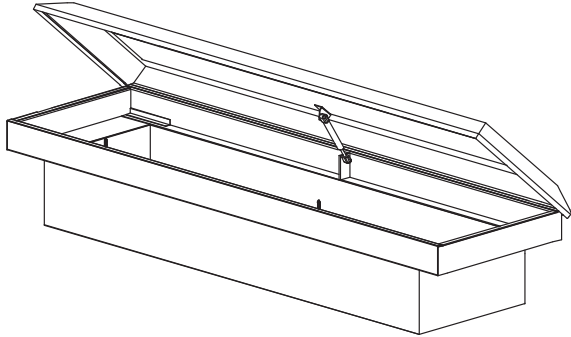

3/8" J-Bolt (2)



3/8" Flatwasher (2)



3/8" Lockwasher (2)



3/8" Hex Nut (2)



Vinyl Cap (2)



Plastic Plug (2)



Foam Tape (2)

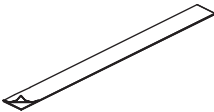

Toolbox Tray (1)

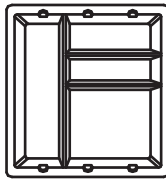

Top View

Side View

TOOLS REQUIRED:

9/16" Wrench / Socket

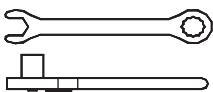

Drill with a 3/8" Drillbit

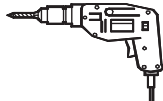

Scissors

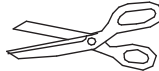

Safety Glasses



Installation

INSTALLATION INSTRUCTIONS:



CAUTION: THIS INSTALLATION REQUIRES USE OF POWER TOOLS. SAFETY GLASSES SHOULD BE WORN AT ALL TIMES DURING THE USE OF THE POWER TOOLS.



CAUTION: IF YOU ARE UNABLE TO LIFT A MINIMUM OF 75 LBS., THEN THIS INSTALLATION WILL REQUIRE THE USE OF TWO PEOPLE.



CAUTION: PINCH AREA BETWEEN BODY AND LID OF TOOLBOX. (FIG. 1)



Scissors

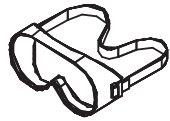

Safety Glasses

1. Peel backing off the foam gasket (H). (Fig. 2)
2. Attach the foam gasket (H) onto the bottom of the toolbox (A). Trim the foam gasket (H) flush with the ends of the toolbox (A). (Fig. 3)
3. Carefully place the toolbox (A) into the back of the pickup bed. (Fig. 4)

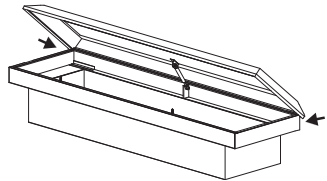

(Fig. 1)

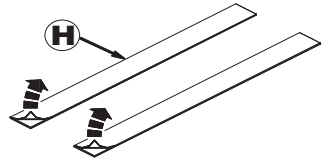

(Fig. 2)

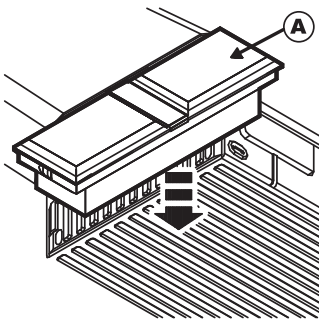

(Fig. 4)

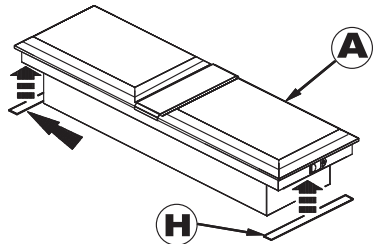

(Fig. 3)

Installation

INSTALLATION INSTRUCTIONS (CONTINUED):



CAUTION: SAFETY GLASSES SHOULD BE WORN DURING THIS STEP OF THE INSTALLATION.

- Using Figures 5 and 6, mark the mounting hole locations for the J-hooks. The mounting hole locations should be centered inside the toolbox (A) and near the lip of the truck bed rail as shown below.

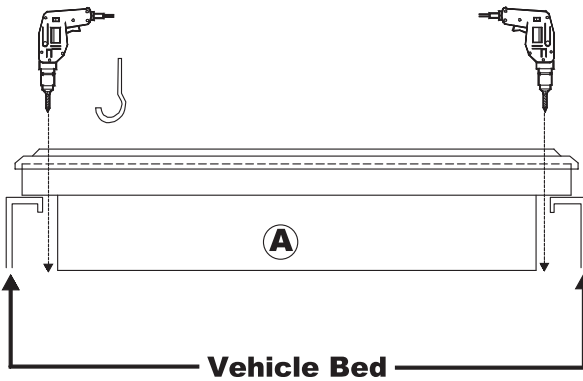

(Fig.5)

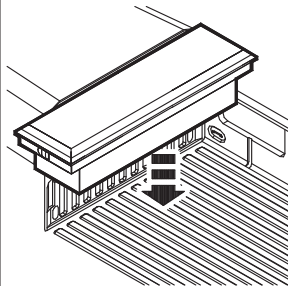
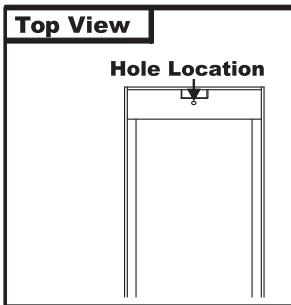

(Fig. 6)



Drill with a 3/8" drillbit

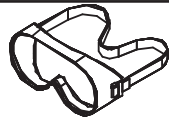

Safety Glasses

Installation

INSTALLATION INSTRUCTIONS (CONTINUED):

- Secure the toolbox (A) to the vehicle truck bed using the 3/8" J-bolts (B), 3/8" flatwasher (C), 3/8" lockwashers (D), and the 3/8" hex nuts (E). Tighten into place using a 9/16" wrench / socket. (Fig. 7)
- Now place the vinyl cap (F) onto the exposed threads of the 3/8" J-bolts (B). (Fig. 8)

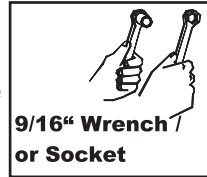

NOTE: After drilling, it is recommended that a sealant or rust inhibitor be placed around all holes drilled into the body panel of the vehicle.

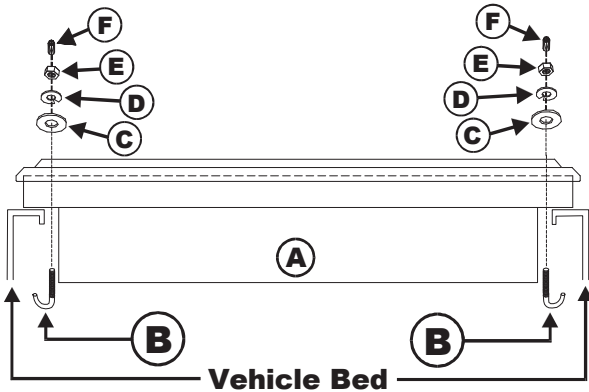

(Fig.7)

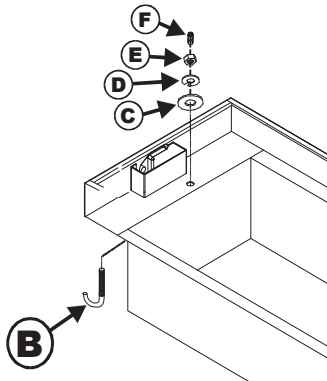

(Fig. 8)

Maintenance

MAINTENANCE INSTRUCTIONS:

CLEANING INSTRUCTIONS:

To maintain the luster of your toolbox, use a mild detergent.

NOTE: Locks are provided as a deterrent to inadvertent opening or easy access to the contents of your toolbox. Contents stored in the toolbox are the responsibility of the user.

LUBRICATION INSTRUCTIONS:

All locks, latches, latching rods, and hinges should be lubricated regularly to assure smooth and proper operation for the life of the toolbox. Lubricate the following locations.

Toolbox Latch Assembly

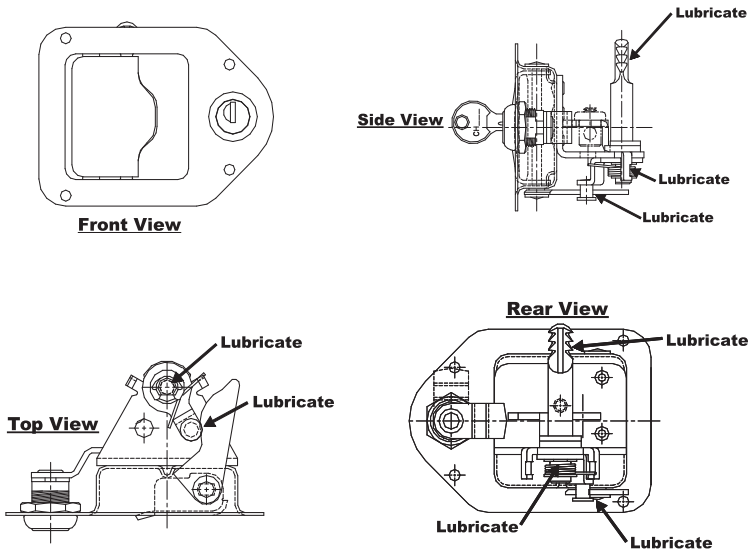

Toolbox Catch Assembly

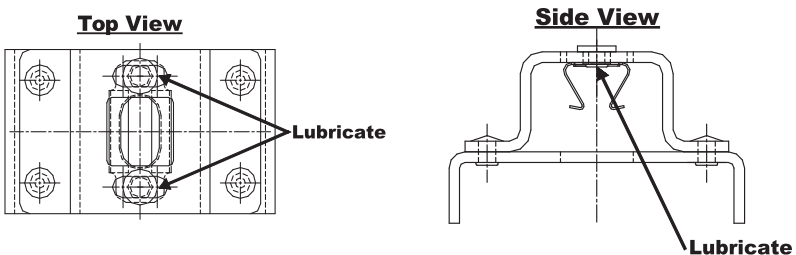

Notes

